

A N A L Y S E N T E C H N I K



2010

HPLC-Säulen & Materialien

Entwicklung • Herstellung
Vertrieb • Beratung

HPLC-Säulen

- Neu + Refill
- umfangreiche Auswahl an Packungsmaterialien
- micro • analytisch • präparativ

Vertriebspartner für:

- GRACEVYDAC
- GL-SCIENCES / INERTSIL
- THERMO SCIENTIFIC
- Eka Nobel / KROMASIL
- CHROMTECH
- DAICEL
- MERCK
- ES-INDUSTRIES

MZ-PAH

- Trennung von PAK's
- 3 µm & 5 µm

MZ-PBM

- Trennung von Pestiziden

MZ-Gel SDTM

- GPC-Säulen Organisch Styrol-Divinylbenzol

HEMA/HEMA-Bio

- GPC-Säulen wässrig

Zubehör

- RHEODYNE-Ventile
- EXMIRE-Spritzen
- Vorsäulensysteme
- Kapillaren
- Verschraubungen uvm.

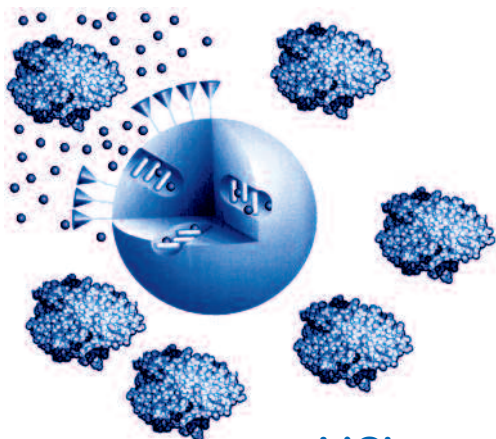

ChiraSep®

Chiraspher®

ChiraDex®

Purospher®

Superspher®

LiChrospher® ADS

LiChrosil®

Aluspher®

LiChrogel® PS

LiChrospher®

Purospher® STAR

LiChrosorb®

HitHunter®

Chromolith®

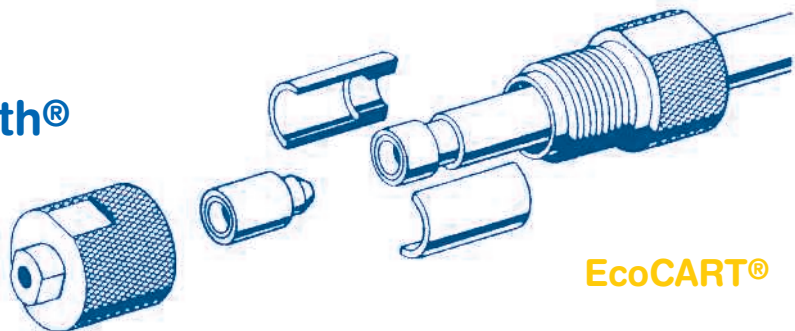

EcoCART®

Hibar®

MicroCART®

ManuCART®

LiChroCART®

Hibar® RT

Aktuelle Infos im Internet:
<http://www.mz-at.de>
 e-mail: info@mz-at.de



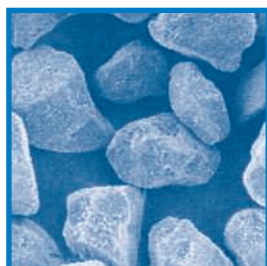

Lichrosorb®

- seit vielen Jahren bewährt
- total porös
- gebrochene Teilchen
- feinklassiert
- viele Modifizierungen erhältlich
- kontrollierte Belegung

Bulkmaterialien

Lichrosorb®

Best.-Nr.	Beschreibung	Menge	€
1.09309.0010	10 µm Si 100	10 g	64,80
1.13969.0010	7 µm CN	10 g	303,00
1.09318.0010	10 µm RP-8	10 g	294,00
1.09318.0100	10 µm RP-8	100 g	2.450,00
1.09333.0010	5 µm RP-18	10 g	323,00
1.09334.0010	10 µm RP-18	10 g	294,00

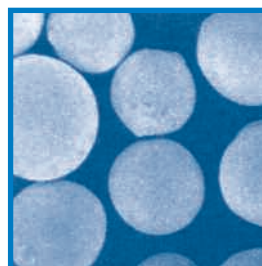

Lichrospher®

- total porös
- Teilchengröße: 5 & 10 µm
- Porenweiten: 6, 10 & 30 nm
- feinklassiert
- viele Modifizierungen erhältlich
- kontrollierte Belegung

Bulkmaterialien

Lichrospher®

Best.-Nr.	Beschreibung	Menge	€
1.19640.0010	5 µm Si 60	10 g	196,00
1.19640.0100	5 µm Si 60	100 g	1.600,00
1.19629.0010	10 µm Si 60	10 g	196,00
1.19641.0010	5 µm 60 RP-select B	10 g	664,00
1.19641.0100	5 µm 60 RP-select B	100 g	5.630,00
1.19642.0010	10 µm 60 RP-select B	10 g	591,00
1.16129.0010	5 µm 100 RP-8	10 g	519,00
1.16139.0010	10 µm 100 RP-8	10 g	519,00
1.19636.0010	5 µm 100 RP-8 endcapped	10 g	519,00
1.19632.0010	10 µm 100 RP-8 endcapped	10 g	519,00
1.16177.0010	5 µm 100 RP-18	10 g	519,00
1.16177.0100	5 µm 100 RP-18	100 g	4.160,00
1.16105.0010	10 µm 100 RP-18	10 g	519,00
1.19637.0010	5 µm 100 RP-18 endcapped	10 g	519,00
1.19637.0100	5 µm 100 RP-18 endcapped	100 g	4.070,00
1.19633.0010	10 µm 100 RP-18 endcapped	10 g	519,00
1.16178.0010	5 µm 100 NH2	10 g	519,00
1.19638.0010	5 µm 100 CN	10 g	519,00
1.19631.0010	10 µm 100 CN	10 g	471,00
1.16152.0010	5 µm 100 DIOL	10 g	519,00
1.19662.0500	12 µm WP 300 RP-18	500 g	2.690,00
1.19659.0100	15 µm WP 300 RP-18	100 g	692,00
1.19659.0500	15 µm WP 300 RP-18	500 g	2.640,00

Bulkmaterialien

Superspher®

Best.-Nr.	Beschreibung	Menge	€
1.19609.0010	4 µm Si 60 für die HPLC	10 g	323,00
1.19612.0010	4 µm 60 RP-8	10 g	607,00
1.19617.0010	4 µm 60 RP-8 endcapped	10 g	607,00
1.19617.0100	4 µm 60 RP-8 endcapped	100 g	4.120,00
1.19613.0010	4 µm 100 RP-18	10 g	607,00
1.19613.0100	4 µm 100 RP-18	100 g	3.730,00
1.19618.0010	4 µm 100 RP-18 endcapped	10 g	607,00
1.19643.0010	4 µm 60 RP-select B	10 g	771,00

Erkältungsmittel

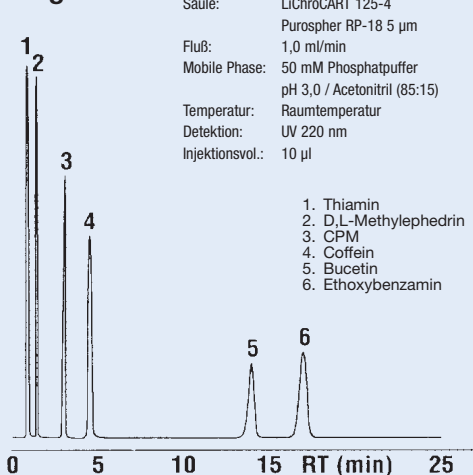

LiChrospher ADS®

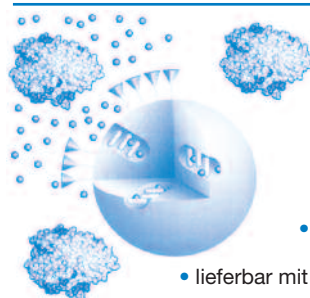

- hoher Probendurchsatz
- hohe Reproduzierbarkeit
- niedrige Kosten pro Probe
- Restricted Access-Material
- LC-integrierte Probenaufbereitung
- lieferbar mit C4-, C8- sowie C18-Modifizierung
- direkte Injektion unbehandelter biologischer Flüssigkeiten

Bulkmaterialien

Cellulosetriacetat

Best.-Nr.	Beschreibung	Menge	€
1.16362.0250	15-25 µm Cellulosetriacetat für die chromatographische Enantiomertrennung	250 g	624,00

Bulkmaterialien

LiChrospher ADS

Best.-Nr.	Beschreibung	Menge	€
1.50347.0010	RP18 ADS für die integrierte Probenaufbereitung	10 g	1.790,00

LiChroCART®

ChiraDex®

Best.-Nr.	Beschreibung	€
1.50201.7004	10 x 2 mm 5 µm 100 LiChroCART 3 Stk.	☎
1.50229.7004	30 x 2 mm 5 µm 100 LiChroCART	☎
1.50234.7004	55 x 2 mm 5 µm 100 LiChroCART	☎
1.50195.7004	125 x 2 mm 5 µm 100 LiChroCART	☎
1.50190.7004	250 x 2 mm 5 µm 100 LiChroCART	☎
1.50233.7004	30 x 3 mm 5 µm 100 LiChroCART	☎
1.50236.7004	55 x 3 mm 5 µm 100 LiChroCART	☎
1.50175.7004	125 x 3 mm 5 µm 100 LiChroCART	☎
1.50177.7004	250 x 3 mm 5 µm 100 LiChroCART	☎
1.50117.0001	4 x 4 mm 5 µm 100 Vorsäule 10 Stk.	255,00
1.50302.7004	30 x 4 mm 5 µm 100 LiChroCART	☎
1.50228.7004	55 x 4 mm 5 µm 100 LiChroCART	☎
1.50171.7004	75 x 4 mm 5 µm 100 LiChroCART	☎
1.50170.7004	125 x 4 mm 5 µm 100 LiChroCART	☎
1.51333.0001	250 x 4 mm 5 µm 100 Kartusche	812,00
1.51448.7004	100 x 4,6 mm 5 µm 100 LiChroCART	☎
1.51442.7004	125 x 4,6 mm 5 µm 100 LiChroCART	☎
1.51432.7004	150 x 4,6 mm 5 µm 100 LiChroCART	☎
1.51431.7004	250 x 4,6 mm 5 µm 100 LiChroCART	☎

Hibar®

ChiraDex®

Best.-Nr.	Beschreibung	€
1.00423.7004	250 x 3 mm 5 µm 100 Hibar	☎
1.51196.7004	30 x 4 mm 5 µm 100 Hibar	☎
1.50181.7004	125 x 4 mm 5 µm 100 Hibar	☎
1.50182.7004	250 x 4 mm 5 µm 100 Hibar	☎
1.50013.7004	100 x 4,6 mm 5 µm 100 Hibar	☎
1.50012.7004	125 x 4,6 mm 5 µm 100 Hibar	☎
1.50009.7004	150 x 4,6 mm 5 µm 100 Hibar	☎
1.00424.7004	250 x 4,6 mm 5 µm 100 Hibar	☎

Methadon

Säule: LiChroCART 250-4
ChiraDex
Fluß: 0,8 ml/min
Mobile Phase: Triethylammoniumacetat-Lösung
(1 % pH 4,1/Acetonitril 98/2 (v/v))
Detektion: UV 254 nm

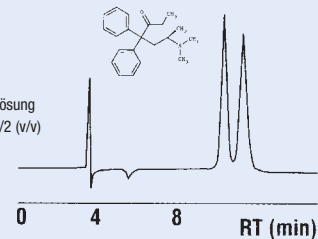

Hibar/LiChroCART

Chiraspher 100 NT

Best.-Nr.	Beschreibung	€
1.00423.7006	250 x 3 mm 5 µm Hibar	☎
1.51196.7006	30 x 4 mm 5 µm Hibar	☎
1.50182.7006	250 x 4 mm 5 µm Hibar	☎
1.50181.7006	125 x 4 mm 5 µm Hibar	☎
1.50013.7006	100 x 4,6 mm 5 µm Hibar	☎
1.50012.7006	125 x 4,6 mm 5 µm Hibar	☎
1.50009.7006	150 x 4,6 mm 5 µm Hibar	☎
1.00424.7006	250 x 4,6 mm 5 µm Hibar	☎
1.50183.7006	250 x 10 mm 5 µm Hibar	☎
1.50201.7006	10 x 2 mm 5 µm LiChroCART 3 Stk.	☎
1.50229.7006	30 x 2 mm 5 µm LiChroCART	☎
1.50234.7006	55 x 2 mm 5 µm LiChroCART	☎
1.50195.7006	125 x 2 mm 5 µm LiChroCART	☎
1.50190.7006	250 x 2 mm 5 µm LiChroCART	☎
1.50233.7006	30 x 3 mm 5 µm LiChroCART	☎
1.50236.7006	55 x 3 mm 5 µm LiChroCART	☎
1.50175.7006	125 x 3 mm 5 µm LiChroCART	☎
1.50177.7006	250 x 3 mm 5 µm LiChroCART	☎
1.50173.7006	4 x 4 mm 5 µm LiChroCART 10 Stk.	☎
1.50302.7006	30 x 4 mm 5 µm LiChroCART	☎
1.50228.7006	55 x 4 mm 5 µm LiChroCART	☎
1.50171.7006	75 x 4 mm 5 µm LiChroCART	☎
1.50170.7006	125 x 4 mm 5 µm LiChroCART	☎
1.51448.7006	100 x 4,6 mm 5 µm LiChroCART	☎
1.51442.7006	125 x 4,6 mm 5 µm LiChroCART	☎
1.51432.7006	150 x 4,6 mm 5 µm LiChroCART	☎
1.51431.7006	250 x 4,6 mm 5 µm LiChroCART	☎
1.50178.7006	10 x 10 mm 5 µm LiChroCART	☎
1.51446.7006	50 x 10 mm 5 µm LiChroCART	☎
1.51449.7006	75 x 10 mm 5 µm LiChroCART	☎
1.51445.7006	100 x 10 mm 5 µm LiChroCART	☎
1.51443.7006	125 x 10 mm 5 µm LiChroCART	☎
1.51444.7006	150 x 10 mm 5 µm LiChroCART	☎
1.50179.7006	250 x 10 mm 5 µm LiChroCART	☎

Hibar/LiChroCART

Chirasep 100 DNBPG

Best.-Nr.	Beschreibung	€
1.00423.7005	250 x 3 mm 5 µm Hibar	☎
1.51196.7005	30 x 4 mm 5 µm Hibar	☎
1.50181.7005	125 x 4 mm 5 µm Hibar	☎
1.50182.7005	250 x 4 mm 5 µm Hibar	☎
1.50013.7005	100 x 4,6 mm 5 µm Hibar	☎
1.50012.7005	125 x 4,6 mm 5 µm Hibar	☎
1.50009.7005	150 x 4,6 mm 5 µm Hibar	☎
1.00424.7005	250 x 4,6 mm 5 µm Hibar	☎
1.50183.7005	250 x 10 mm 5 µm Hibar	☎
1.50201.7005	10 x 2 mm 5 µm LiChroCART 3 Stk.	☎
1.50229.7005	30 x 2 mm 5 µm LiChroCART	☎
1.50234.7005	55 x 2 mm 5 µm LiChroCART	☎
1.50195.7005	125 x 2 mm 5 µm LiChroCART	☎
1.50190.7005	250 x 2 mm 5 µm LiChroCART	☎
1.50236.7005	55 x 3 mm 5 µm LiChroCART	☎
1.50233.7005	30 x 3 mm 5 µm LiChroCART	☎
1.50175.7005	125 x 3 mm 5 µm LiChroCART	☎
1.50177.7005	250 x 3 mm 5 µm LiChroCART	☎
1.50302.7005	30 x 4 mm 5 µm LiChroCART	☎
1.50228.7005	55 x 4 mm 5 µm LiChroCART	☎
1.50171.7005	75 x 4 mm 5 µm LiChroCART	☎
1.50170.7005	125 x 4 mm 5 µm LiChroCART	☎
1.50174.7005	250 x 4 mm 5 µm LiChroCART	☎
1.51448.7005	100 x 4,6 mm 5 µm LiChroCART	☎
1.51442.7005	125 x 4,6 mm 5 µm LiChroCART	☎
1.51432.7005	150 x 4,6 mm 5 µm LiChroCART	☎
1.51431.7005	250 x 4,6 mm 5 µm LiChroCART	☎
1.50178.7005	10 x 10 mm 5 µm LiChroCART 2 Stk.	☎
1.51446.7005	50 x 10 mm 5 µm LiChroCART	☎
1.51449.7005	75 x 10 mm 5 µm LiChroCART	☎
1.51445.7005	100 x 10 mm 5 µm LiChroCART	☎
1.51443.7005	125 x 10 mm 5 µm LiChroCART	☎
1.51444.7005	150 x 10 mm 5 µm LiChroCART	☎
1.50179.7005	250 x 10 mm 5 µm LiChroCART	☎

LiChrospher ADS®

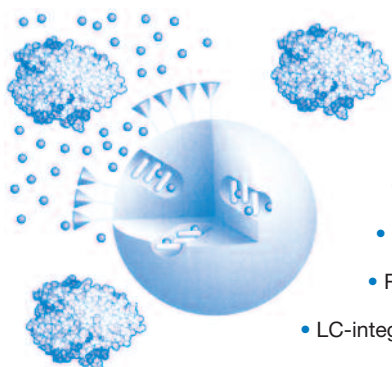

- hoher Probendurchsatz
- hohe Reproduzierbarkeit
- niedrige Kosten pro Probe
- Restricted Access-Material
- LC-integrierte Probenaufbereitung
- lieferbar mit C4-, C8- sowie C18-Modifizierung
- direkte Injektion unbehandelter biologischer Flüssigkeiten

LiChroCART®

LiChrospher® ADS

Best.-Nr.	Beschreibung	€
1.50210.0001	25 x 4 mm HPLC Selektivitätskit <i>enthält: je 1 LiChroCART 25-4 RP-4 ADS / RP-8 ADS / RP-18 ADS + 1 manu-CART</i>	1.510,00
1.50380.0001	25 x 2 mm RP-4 ADS	370,00
1.50381.0001	25 x 2 mm RP-4 ADS (3 Stk.)	983,00
1.50206.0001	25 x 4 mm RP-4 ADS (Satz) <i>enthält: 1 LiChroCART 25-4 RP-4 ADS 1 manu-CART</i>	617,00
1.50208.0001	25 x 4 mm RP-4 ADS (3 Stk.)	1.350,00
1.50382.0001	25 x 2 mm RP-8 ADS	370,00
1.50383.0001	25 x 2 mm RP-8 ADS (3 Stk.)	958,00
1.50207.0001	25 x 4 mm RP-8 ADS (Satz) <i>enthält: 1 LiChroCART 25-4 RP-8 ADS 1 manu-CART</i>	614,00
1.50209.0001	25 x 4 mm RP-8 ADS (3 Stk.)	1.350,00
1.50386.0001	25 x 2 mm RP-18 ADS (3 Stk.)	983,00
1.50385.0001	25 x 2 mm RP-18 ADS	370,00
1.50187.0001	25 x 4 mm RP-18 ADS (Satz) <i>enthält: 1 LiChroCART 25-4 RP-18 ADS 1 manu-CART</i>	609,00
1.50947.0001	25 x 4 mm RP-18 ADS (3 Stk.)	1.350,00

Edelstahl-Säulen HitHunter®

HitHunter®

Purospher®

Best.-Nr.	Beschreibung	€
1.50278.0001	30 x 10 mm 5 µm STAR RP-8 endc.	499,00
1.50283.0001	50 x 10 mm 5 µm STAR RP-18 endc.	680,00
1.50282.0001	50 x 10 mm 5 µm STAR RP-8 endc.	680,00
1.50287.0001	100 x 10 mm 5 µm STAR RP-18 endc.	832,00
1.50286.0001	100 x 10 mm 5 µm STAR RP-8 endc.	832,00
1.50292.0001	30 x 21,2 mm 5 µm STAR RP-18 endc.	1.110,00
1.50296.0001	50 x 21,2 mm 5 µm STAR RP-18 endc.	1.560,00
1.50295.0001	50 x 21,2 mm 5 µm STAR RP-8 endc.	1.560,00
1.50299.0001	100 x 21,2 mm 5 µm STAR RP-8 endc.	2.180,00
1.50322.0001	30 x 25 mm 5 µm STAR RP-18 endc.	1.410,00
1.50319.0001	30 x 25 mm 5 µm STAR RP-8 endc.	1.410,00
1.50326.0001	50 x 25 mm 5 µm STAR RP-18 endc.	2.950,00
1.50325.0001	50 x 25 mm 5 µm STAR RP-8 endc.	2.960,00

HitHunter® Säulen sind optimiert f. d. kombinatorische Chemie

HPLC-Säulen

Polyspher®

Best.-Nr.	Beschreibung	€
1.51184.0001	10 x 3 mm IC AN-S 3 Stk Vorsäulen	488,00
1.19673.0001	250 x 4 mm IC Scout column	634,00

LiChroCART®

Nucleosil®

Best.-Nr.	Beschreibung	€
1.51402.0003	125 x 4 mm 5 µm C8	307,00
1.51387.0003	250 x 4 mm 5 µm C8	369,00
1.51377.0003	250 x 4 mm 10 µm C8	368,00
1.51324.0003	4 x 4 mm 5 µm C18 (10 Stk)	266,00
1.51329.0003	125 x 4 mm 5 µm C18	328,00
1.51388.0003	250 x 4 mm 5 µm C18	389,00
1.51378.0003	250 x 4 mm 10 µm C18	368,00

HPLC-Fertigsäule RT

LiChrosil® CA

Best.-Nr.	Beschreibung	€
1.50160.0001	10 x 4,6 mm LiChrosil IC CA	736,00

LiChroCART®

Aluspher®

Best.-Nr.	Beschreibung	€
1.51310.0001	4 x 4 mm 5 µm Al 100 (10 Stk.)	251,00
1.51311.0001	4 x 4 mm 5 µm 100 RP-select B (10 Stk.)	251,00
1.51315.0001	125 x 4 mm 5 µm 100 RP-select B	556,00
1.51318.0001	250 x 4 mm 5 µm 100 RP-select B	657,00

Glaskartuschen EcoCART®



EcoCART®

125 x 3 mm

Best.-Nr.	Beschreibung	€
1.51233.0001	5 µm LiChrospher 60 RP-select B (3 Stk)	758,00
1.51232.0001	5 µm LiChrospher 100 RP-18 (3 Stk)	697,00
1.51427.0001	5 µm LiChrospher 100 RP-18 endc. (3 Stk)	697,00
1.51425.0001	5 µm Superspher 60 RP-select B	311,00
1.51423.0001	5 µm Superspher 100 RP-18 endc.	311,00
1.50180.7130	5 µm Purospher RP-18e	☎
1.50180.7127	5 µm Purospher RP-18	☎
1.50180.7005	5 µm Chirasep 100 DNBPG	☎
1.50180.7004	5 µm ChiraDex 100	☎
1.50180.7006	5 µm Chiraspher 100	☎

EcoCART®

Zubehör

Best.-Nr.	Beschreibung	€
1.51207.0001	Halterung f. EcoCART 125-3 <i>1 Spannrohr, 2 manu-CART '4' Überwurfmuttern, 1 Vorsäulenhalter</i>	331,00
1.51420.0001	manu-CART '4' Zusatzkit f. EcoCART 125-3 <i>1 Spannrohr, 1 Vorsäulenhalter</i>	111,00

Chromolith®

Chromolith® - monolithische HPLC-Fertigsäulen

Best.-Nr.	Beschreibung	€
1.50403.0001	150 x 0,05 mm CapRod RP18e	1.150,00
1.50402.0001	150 x 0,1 mm CapRod RP18e	1.070,00
1.50404.0001	150 x 0,1 mm CapRod RP18e HR	1.150,00
1.50400.0001	150 x 0,1 mm CapRod RP8e	1.070,00
1.50409.0001	50 x 0,2 mm CapRod RP18e TRAP	333,00
1.50405.0001	150 x 0,2 mm CapRod RP18e	990,00
1.50407.0001	150 x 0,2 mm CapRod RP18e HR	1.170,00
1.52008.0001	5 x 2,1 mm RP-18e Vorsäulenkit	276,00
1.52009.0001	5 x 2,1 mm RP-18e Vorsäule 3 Stück	150,00
1.52007.0001	50 x 2,1 mm RP-18e Fastgradient	578,00
1.52006.0001	100 x 2,1 mm RP-18e	687,00
1.52004.0001	5 x 3,0 mm RP-18e Vorsäulenkit	217,00
1.52005.0001	5 x 3,0 mm RP-18e Vorsäule 3 Stück	143,00
1.52003.0001	25 x 3,0 mm RP-18e Flash	345,00
1.52002.0001	50 x 3,0 mm SpeedROD RP-18e	545,00
1.52001.0001	100 x 3,0 mm RP-18e	838,00
1.51470.0001	5 x 4,6 mm RP-18e Vorsäulenkit	276,00
1.51451.0001	5 x 4,6 mm RP-18e Vorsäule 3 Stück	203,00
1.51471.0001	10 x 4,6 mm RP-18e Vorsäulenkit	307,00
1.51452.0001	10 x 4,6 mm RP-18e Vorsäule 3 Stück	244,00
1.51463.0001	25 x 4,6 mm Flash RP-18e	350,00
1.51450.0001	50 x 4,6 mm SpeedROD RP-18e	524,00
1.02129.0001	100 x 4,6 mm Performance RP-18e	695,00
1.51466.0001	100 x 4,6 mm Validierungskit 3 Stk. RP-18e	2.050,00
1.51465.0001	100 x 4,6 mm Performance Si	723,00
1.51468.0001	100 x 4,6 mm Performance RP-8e	723,00
1.52016.0001	100 x 10 mm Chromolith Semiprep RP-18e	1.590,00
1.25251.0001	100 x 25 mm Chromolith Prep Si	5.790,00
1.25252.0001	100 x 25 mm Chromolith Prep RP-18e	6.030,00

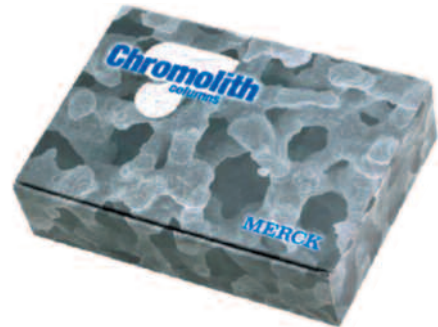

Chromolith® - Zubehör

Best.-Nr.	Beschreibung	€
1.25254.0001	Dichtungset für Chromolith prep	279,00
1.25256.0001	Satz Endverschraubungen Chromolith prep	539,00
1.25257.0001	Frittenset für Chromolith prep	193,00
1.25255.0001	Werkzeugset für Chromolith prep	266,00
1.51467.0001	Kopplungsstück, totvolumenfrei	43,20
1.25259.0001	Chromolith prep Kopplungsteil	43,20

Hibar® RT

LiChrogel® PS

Best.-Nr.	Beschreibung	€
1.50056.0001	250 x 7 mm 10 µm LiChrogel PS 40	1.960,00

MicroCART®

Purospher®

Best.-Nr.	Beschreibung	€
1.09018.0001	150 x 1 mm 5 µm RP-18 endc.	826,00
1.50258.0001	150 x 1 mm 5 µm STAR RP-18 endc.	1.410,00

Hibar® RT

LiChrospher®

Best.-Nr.	Beschreibung	€
1.50316.0001	250 x 4 mm 5 µm Si100	481,00
1.50329.0001	250 x 4 mm 5 µm 100 RP-8	511,00
1.50477.0001	125 x 4 mm 5 µm 100 RP-18	452,00
1.50377.0001	250 x 4 mm 5 µm 100 RP-18	511,00
1.51483.0001	250 x 25 mm 5 µm 100 RP-18	2.390,00
1.51482.0001	250 x 25 mm 5 µm 100 RP-8	2.440,00
1.51484.0001	250 x 25 mm 5 µm 60 RP-Select B	2.260,00
1.51485.0001	250 x 25 mm 5 µm Si 60	2.050,00

LiChroCART®

LiChrosorb®

Best.-Nr.	Beschreibung	€
1.51343.0001	125 x 4 mm 5 µm Si 60	290,00
1.51351.0001	250 x 4 mm 5 µm Si 60	323,00
1.51345.0001	125 x 4 mm 5 µm RP-8	305,00
1.51353.0001	250 x 4 mm 5 µm RP-8	341,00
1.51354.0001	250 x 4 mm 10 µm RP-8	341,00
1.51349.0001	125 x 4 mm 5 µm RP-18	305,00
1.51355.0001	250 x 4 mm 5 µm RP-18	341,00
1.51356.0001	250 x 4 mm 10 µm RP-18	341,00

Hibar® RT

LiChrosorb®

Best.-Nr.	Beschreibung	€
1.50388.0001	250 x 4 mm 5 µm Si 60	462,00
1.50432.0001	125 x 4 mm 5 µm RP-8	442,00
1.50332.0001	250 x 4 mm 5 µm RP-8	483,00
1.50318.0001	250 x 4 mm 10 µm RP-8	483,00
1.51441.0001	250 x 25 mm 7 µm RP-8	2.690,00
1.50433.0001	125 x 4 mm 5 µm RP-18	442,00
1.50333.0001	250 x 4 mm 5 µm RP-18	483,00
1.50334.0001	250 x 4 mm 10 µm RP-18	483,00

LiChroCART®

LiChrospher®

Best.-Nr.	Beschreibung	€
1.50156.0001	250 x 3 mm PAH	622,00
1.50148.0001	4 x 4 mm PAH (10 Stk.)	250,00
1.50149.0001	250 x 4 mm PAH	564,00
1.50955.0001	4 x 4 mm 5 µm Si 60 Si (10 Stk.)	250,00
1.50928.0001	25 x 4 mm 5 µm Si 60 (3 Stk.)	265,00
1.50820.0001	125 x 4 mm 5 µm Si 60	298,00
1.50830.0001	250 x 4 mm 5 µm Si 60	347,00
1.50840.0001	250 x 4 mm 10 µm Si 60	347,00
1.50850.0001	250 x 10 mm 10 µm Si 60	944,00
1.50158.0001	125 x 3 mm 5 µm 60 RP-select B	333,00
1.50155.0001	250 x 3 mm 5 µm 60 RP-select B	406,00
1.50963.0001	4 x 4 mm 5 µm 60 RP-select B (10 Stk.)	250,00
1.50937.0001	25 x 4 mm 5 µm 60 RP-select B (3 Stk.)	331,00
1.50993.0001	75 x 4 mm 5 µm 60 RP-select B (3 Stk.)	406,00
1.50829.0001	125 x 4 mm 5 µm 60 RP-select B	341,00
1.50981.0001	125 x 4 mm 5 µm 60 RP-select B (3 Stk.)	692,00
1.50839.0001	250 x 4 mm 5 µm 60 RP-select B	416,00
1.50984.0001	250 x 4 mm 5 µm 60 RP-select B (3 Stk.)	905,00
1.50742.0001	250 x 4 mm 10 µm 60 RP-select B	416,00
1.50173.7082	4 x 4 mm 10 µm 60 RP-18 (10 Stk.)	☎
1.50170.7195	125 x 4 mm 5 µm WP 200 RP-4	☎
1.50140.0001	4 x 4 mm 5 µm WP 300 RP-18 (10 Stk.)	251,00
1.50137.0001	250 x 4 mm 5 µm WP 300 RP-18	470,00
1.50183.7114	250 x 10 mm 12 µm WP 300 RP-18*	☎

*Hibar®

LiChroCART®

LiChrospher®

Best.-Nr.	Beschreibung	€
1.50956.0001	4 x 4 mm 5 µm 100 RP-8 (10 Stk.)	250,00
1.50930.0001	25 x 4 mm 5 µm 100 RP-8 (3 Stk.)	292,00
1.50986.0001	75 x 4 mm 5 µm 100 RP-8 (3 Stk.)	363,00
1.50822.0001	125 x 4 mm 5 µm 100 RP-8	316,00
1.50942.0001	125 x 4 mm 5 µm 100 RP-8 (3 Stk.)	404,00
1.50832.0001	250 x 4 mm 5 µm 100 RP-8	380,00
1.50982.0001	250 x 4 mm 5 µm 100 RP-8 (3 Stk.)	753,00
1.50842.0001	250 x 4 mm 10 µm 100 RP-8	380,00
1.50945.0001	10 x 10 mm 10 µm 100 RP-8 (2 Stk.)	234,00
1.50961.0001	4 x 4 mm 5 µm 100 RP-8 endc. (10 Stk.)	250,00
1.50827.0001	125 x 4 mm 5 µm 100 RP-8 endc.	316,00
1.50837.0001	250 x 4 mm 5 µm 100 RP-8 endc.	380,00
1.50847.0001	250 x 4 mm 10 µm 100 RP-8 endc.	380,00
1.50159.0001	125 x 3 mm 5 µm 100 RP-18	341,00
1.50102.0001	125 x 3 mm 5 µm 100 RP-18 (Satz) <i>enthält: 1 LiChroCART 4-4 / 1 LiChroCART 125-3 / 1 manu-CART</i>	341,00
1.50154.0001	250 x 3 mm 5 µm 100 RP-18	416,00
1.50957.0001	4 x 4 mm 5 µm 100 RP-18 (10 Stk.)	250,00
1.50931.0001	25 x 4 mm 5 µm 100 RP-18 (3 Stk.)	292,00
1.50987.0001	75 x 4 mm 5 µm 100 RP-18 (3 Stk.)	363,00
1.50823.0001	125 x 4 mm 5 µm 100 RP-18	316,00
1.50943.0001	125 x 4 mm 5 µm 100 RP-18 (3 Stk.)	404,00
1.50833.0001	250 x 4 mm 5 µm 100 RP-18	380,00
1.50983.0001	250 x 4 mm 5 µm 100 RP-18 (3 Stk.)	753,00
1.50170.7080	125 x 4 mm 7 µm 100 RP-18	☎
1.50174.7080	250 x 4 mm 7 µm 100 RP-18	☎
1.50170.7081	125 x 4 mm 10 µm 100 RP-18	☎
1.50843.0001	250 x 4 mm 10 µm 100 RP-18	380,00
1.50853.0001	250 x 10 mm 10 µm 100 RP-18	1.090,00
1.50962.0001	4 x 4 mm 5 µm 100 RP-18 endc. (10 Stk.)	250,00
1.50936.0001	25 x 4 mm 5 µm 100 RP-18 endc. (3 Stk.)	292,00
1.50828.0001	125 x 4 mm 5 µm 100 RP-18 endc.	316,00
1.50734.0001	125 x 4 mm 5 µm 100 RP-18 endc. (3 Stk.)	483,00
1.50838.0001	250 x 4 mm 5 µm 100 RP-18 endc.	380,00
1.50995.0001	250 x 4 mm 5 µm 100 RP-18 endc. (3 Stk.)	753,00
1.50848.0001	250 x 4 mm 10 µm 100 RP-18 endc.	380,00
1.50858.0001	250 x 10 mm 10 µm 100 RP-18 endc.	1.090,00
1.50958.0001	4 x 4 mm 5 µm 100 NH2 (10 Stk.)	250,00
1.50932.0001	25 x 4 mm 5 µm 100 NH2 (3 Stk.)	292,00
1.50824.0001	125 x 4 mm 5 µm 100 NH2	316,00
1.50834.0001	250 x 4 mm 5 µm 100 NH2	380,00
1.50844.0001	250 x 4 mm 10 µm 100 NH2	380,00
1.50959.0001	125 x 2 mm 5 µm 100 CN	250,00
1.50175.7071	125 x 3 mm 5 µm 100 CN	☎
1.50959.0001	4 x 4 mm 5 µm 100 CN (10 Stk.)	250,00
1.50171.7071	75 x 4 mm 5 µm 100 CN	☎
1.50825.0001	125 x 4 mm 5 µm 100 CN	316,00
1.50892.0001	250 x 4 mm 5 µm 100 CN	380,00
1.51432.7071	150 x 4,6 mm 5 µm 100 CN	☎
1.51431.7071	250 x 4,6 mm 5 µm 100 CN	☎
1.50845.0001	250 x 4 mm 10 µm 100 CN	380,00
1.50960.0001	4 x 4 mm 5 µm 100 DIOL (10 Stk.)	250,00
1.50172.7075	25 x 4 mm 5 µm 100 DIOL	☎
1.50826.0001	125 x 4 mm 5 µm 100 DIOL	316,00
1.50836.0001	250 x 4 mm 5 µm 100 DIOL	380,00

Pestizide

Säule: LiChroCART 250-4
LiChrospher 60 RP select B 5 µm
Fluß: 0,8 ml/min
Mobile Phase: A: Natriumacetat 0,5 mmol/l
B: Acetonitril
Gradient: 0 min 20 % B -> 20 min 28 % B
const. bis 35 min -> 75 min 55 % B
Temperatur: 22 °C
Detektion: UV 215 nm
Injektionsvol.: 100 µl

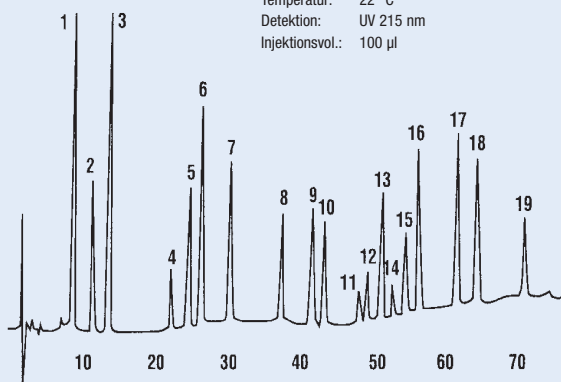

- | | | |
|-----------------------|---------------------|-----------------|
| 1 Desisopropylatrazin | 8 Metabenzthiazuron | 15 Metazachlor |
| 2 Hydroxyatrazin | 9 Atrazin | 16 Sebutylazin |
| 3 Desethylatrazin | 10 Chlortoluron | 17 Terbutylazin |
| 4 Hexazinon | 11 Monolinuron | 18 Linuron |
| 5 Metoxuron | 12 Isoproturon | 19 Metolachlor |
| 6 Simazin | 13 Diuron | |
| 7 Cyananazin | 14 Metobromuron | |

LiChroCART®

Purospher®

Best.-Nr.	Beschreibung	€
1.50237.0001	30 x 2 mm 3 µm STAR RP-18e (Satz)	380,00
1.50240.0001	55 x 2 mm 3 µm STAR RP-18e (Satz)	433,00
1.50234.7184	55 x 2 mm 3 µm STAR RP-18e	☎
1.50239.0001	30 x 4 mm 3 µm STAR RP-18e (Satz)	356,00
1.50225.0001	30 x 4 mm 3 µm STAR RP-18e (3 Stk.)	501,00
1.50242.0001	55 x 4 mm 3 µm STAR RP-18e (Satz)	399,00
1.50231.0001	55 x 4 mm 3 µm STAR RP-18e (3 Stk.)	568,00
1.51460.0001	75 x 4 mm 3 µm STAR RP-18e	268,00
1.50255.0001	125 x 2 mm 5 µm STAR RP-18e Li-CART	431,00
1.50256.0001	250 x 2 mm 5 µm STAR RP-18e Li-CART	463,00
1.50253.0001	125 x 3 mm 5 µm STAR RP-18e Li-CART	414,00
1.50254.0001	250 x 3 mm 5 µm STAR RP-18e Li-CART	482,00
1.50234.7220	55 x 2 mm 5 µm STAR RP-8e Li-CART	☎
1.50274.0001	125 x 2 mm 5 µm STAR RP-8e Li-CART	431,00
1.50275.0001	250 x 2 mm 5 µm STAR RP-8e Li-CART	462,00
1.50038.0001	125 x 3 mm 5 µm STAR RP-8e Li-CART	388,00
1.50273.0001	250 x 3 mm 5 µm STAR RP-8e Li-CART	482,00
1.50201.7127	10 x 2 mm 5 µm RP-18 Li-CART (3 Stk)	☎
1.50234.7127	55 x 2 mm 5 µm RP-18 Li-CART	☎
1.50195.7127	125 x 2 mm 5 µm RP-18 Li-CART	☎
1.50190.7127	250 x 2 mm 5 µm RP-18 Li-CART	☎
1.50236.7127	55 x 3 mm 5 µm RP-18 Li-CART	☎
1.50175.7127	125 x 3 mm 5 µm RP-18 Li-CART	☎
1.50177.7127	250 x 3 mm 5 µm RP-18 Li-CART	☎
1.50141.0001	4 x 4 mm 5 µm RP-18 (10 Stk.) Li-CART	250,00
1.50142.0001	125 x 4 mm 5 µm RP-18 Li-CART	462,00
1.50144.0001	250 x 4 mm 5 µm RP-18 Li-CART	512,00
1.51442.7127	125 x 4,6 mm 5 µm RP-18 Li-CART	☎
1.51432.7127	150 x 4,6 mm 5 µm RP-18 Li-CART	☎
1.51431.7127	250 x 4,6 mm 5 µm RP-18 Li-CART	☎
1.50178.7127	10 x 10 mm 5 µm RP-18 (2 Stk) Li-CART	☎
1.51446.7127	50 x 10 mm 5 µm RP-18 Li-CART	☎
1.51443.7127	125 x 10 mm 5 µm RP-18 Li-CART	☎
1.51444.7127	150 x 10 mm 5 µm RP-18 Li-CART	☎
1.50179.7127	250 x 10 mm 5 µm RP-18 Li-CART	☎
1.50201.7130	10 x 2 mm 5 µm RP-18e (3 Stk) Li-CART	☎
1.50234.7130	55 x 2 mm 5 µm RP-18e Li-CART	☎
1.50190.7130	250 x 2 mm 5 µm RP-18e Li-CART	☎
1.50236.7130	55 x 3 mm 5 µm RP-18e Li-CART	☎
1.50798.0001	125 x 3 mm 5 µm RP-18e Li-CART	419,00
1.51384.0001	250 x 3 mm 5 µm RP-18e Li-CART	514,00
1.50228.7130	55 x 4 mm 5 µm RP-18e Li-CART	☎
1.51442.7130	125 x 4,6 mm 5 µm RP-18e Li-CART	☎
1.51432.7130	150 x 4,6 mm 5 µm RP-18e Li-CART	☎
1.51431.7130	250 x 4,6 mm 5 µm RP-18e Li-CART	☎
1.50178.7130	10 x 10 mm 5 µm RP-18e (2 Stk) Li-CART	☎
1.51446.7130	50 x 10 mm 5 µm RP-18e Li-CART	☎
1.51443.7130	125 x 10 mm 5 µm RP-18e Li-CART	☎
1.51444.7130	150 x 10 mm 5 µm RP-18e Li-CART	☎
1.50179.7130	250 x 10 mm 5 µm RP-18e Li-CART	☎
1.50167.0001	4 x 4 mm 5 µm 120 RP-18e (10 Stk) Li-CART	250,00
1.50168.0001	125 x 4 mm 5 µm 120 RP-18e Li-CART	419,00
1.50169.0001	250 x 4 mm 5 µm 120 RP-18e Li-CART	470,00
1.50173.7131	4 x 4 mm 5 µm RP-18 HC Li-CART	☎
1.51431.7131	250 x 4,6 mm 5 µm RP-18 HC Li-CART	☎

Hibar®

Purospher®

Best.-Nr.	Beschreibung	€
1.51196.7130	30 x 4 mm 5 µm RP-18e	☎
1.50181.7130	125 x 4 mm 5 µm RP-18e	☎
1.50182.7130	250 x 4 mm 5 µm RP-18e	☎
1.50013.7130	100 x 4,6 mm 5 µm RP-18e	☎
1.50012.7130	125 x 4,6 mm 5 µm RP-18e	☎
1.50009.7130	150 x 4,6 mm 5 µm RP-18e	☎
1.00424.7130	250 x 4,6 mm 5 µm RP-18e	☎
1.50183.7130	250 x 10 mm 5 µm RP-18e	☎
1.51196.7127	30 x 4 mm 5 µm RP-18	☎
1.50181.7127	125 x 4 mm 5 µm RP-18	☎
1.50182.7127	250 x 4 mm 5 µm RP-18	☎
1.50013.7127	100 x 4,6 mm 5 µm RP-18	☎
1.50012.7127	125 x 4,6 mm 5 µm RP-18	☎
1.50009.7127	150 x 4,6 mm 5 µm RP-18	☎
1.00424.7127	250 x 4,6 mm 5 µm RP-18	☎
1.50183.7127	250 x 10 mm 5 µm RP-18	☎

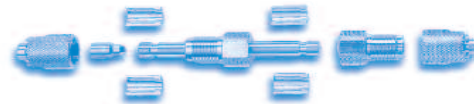

LiChroCART®

Superspher®

Best.-Nr.	Beschreibung	€
1.16054.0001	125 x 4 mm Si 60	409,00
1.16009.0001	250 x 4 mm Si 60	481,00
1.16052.0001	125 x 4 mm 60 RP-8	426,00
1.16010.0001	250 x 4 mm 60 RP-8	513,00
1.16854.0001	125 x 4 mm 60 RP-8 endcapped	426,00
1.16857.0001	250 x 4 mm 60 RP-8 endcapped	513,00
1.50205.0001	10 x 2 mm 60 RP-select B (3 Stk.)	135,00
1.50197.0001	125 x 2 mm 60 RP-select B	557,00
1.51308.0001	250 x 2 mm 60 RP-select B	557,00
1.50791.0001	125 x 3 mm 60 RP-select B	479,00
1.51288.0001	250 x 3 mm 60 RP-select B	514,00
1.50974.0001	75 x 4 mm 60 RP-select B (3 Stk.)	688,00
1.50975.0001	125 x 4 mm 60 RP-select B	479,00
1.50973.0001	250 x 4 mm 60 RP-select B	557,00
1.50204.0001	10 x 2 mm 100 RP-18 (3 Stk.)	135,00
1.16039.0001	25 x 4 mm 100 RP-18 (3 Stk.)	385,00
1.50980.0001	75 x 4 mm 100 RP-18 (3 Stk.)	616,00
1.50200.0001	125 x 2 mm 100 RP-18	470,00
1.50792.0001	125 x 3 mm 100 RP-18	450,00
1.16051.0001	125 x 4 mm 100 RP-18	426,00
1.51299.0001	250 x 3 mm 100 RP-18	514,00
1.16056.0001	250 x 4 mm 100 RP-18	513,00
1.16869.0001	25 x 4 mm 100 RP-18 endcapped (3 Stk.)	385,00
1.50198.0001	125 x 2 mm 100 RP-18 endcapped	470,00
1.50193.0001	250 x 2 mm 100 RP-18 endcapped	514,00
1.16855.0001	125 x 4 mm 100 RP-18 endcapped	426,00
1.16858.0001	250 x 4 mm 100 RP-18 endcapped	513,00

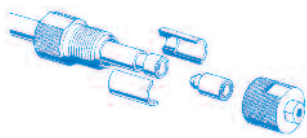

Zubehör

Hibar® RT

Werkzeuge

Best.-Nr.	Beschreibung	€
1.51210.0001	Werkzeug z. Entf. von Fritten Ø 4 mm	51,00

LiChroCART®

Verschlussbelemente

Best.-Nr.	Beschreibung	€
1.51195.0001	Verschlussbelement PVDF 10 Stk.	74,10

Hibar® & LiChroCART®

Kapillarrohre

Best.-Nr.	Beschreibung	€
1.51230.0001	80 x 0,25 mm ID/AD 1/16" (10 Stk)	123,00
1.51231.0001	120 x 0,25 mm ID/AD 1/16" (10 Stk)	132,00
1.15547.0001	250 x 0,2 mm ID/AD 0,5 mm (5 Stk) <i>flexible Edelstahlkapillaren</i>	70,80
1.51236.0001	1.000 x 0,2 mm ID/AD 0,5 mm (3 Stk) <i>flexible Edelstahlkapillaren</i>	142,00
1.51247.0001	150 x 0,1 mm ID/AD 0,5 mm (5 Stk) <i>Hibar® Kapillarrohr für die Mikro-HPLC</i>	85,40
1.51245.0001	1.000 x 0,1 mm ID/AD 0,5 mm (1 Stk) <i>Hibar® Kapillarrohr für die Mikro-HPLC</i>	76,90

Hibar® RT

Ersatzfritten

Best.-Nr.	Beschreibung	€
1.51211.0001	Ø 4 mm 3 Stk mit PTFE-Ringdichtungen	64,30
1.51220.0001	Ø 10 mm 3 Stk mit PTFE-Ringdichtungen	113,00

LiChroCART®

Montagewerkzeug

Best.-Nr.	Beschreibung	€
1.15576.0001	Hibar® LiChroCART® Montagewerkzeug 1 Zentrierhülse, 1 Stempel, 1 Werkzeug zur Entfernung von PTFE-Dichtringen aus LiChroCART-Kartuschen	28,30

LiChroCART®

manu-CART®

Best.-Nr.	Beschreibung	€
1.51486.0001	manu-CART NT Kartuschenhalter f. LiChroCART® Kartuschen ID 2; 3; 4; 4,6 mm	285,00
1.51419.0001	manu-CART '10'-II Verschraubung 2 kompl. Verschraubungen f. LiChroCART® Kartuschen ID 10 mm für Kapillarananschluß (AD 1/16" oder 0,5 mm)	348,00
1.50226.0001	Halter f. LiChroCART 55-4 Kartuschen	177,00
1.50227.0001	Halter f. LiChroCART 30-4 Kartuschen	135,00
1.50082.0001	manu-CART '4' Kopplungseinheit für LiChroCART 25-4 Kartuschen	260,00
1.50017.0001	manu-CART '4' Kartuschenhalter für LiChroCART 25-4 Kartuschen	225,00
1.50083.0001	manu-CART '4' Kopplungsteil zum Koppeln von 2 LiChroCART HPLC-Kartuschen	99,60
1.51258.0001	Druckstück f. manu-CART '4' Verschraubung	106,00
1.51257.0001	Halbschalen f. " '4' Verschraubung	85,20

Hibar® & LiChroCART®

Starter Kit

Best.-Nr.	Beschreibung	€
1.13171.0001	HPLC Starter-Kit 4 Rändelschrauben für Kapillarananschluß (AD 1/16 oder 0,5 mm) 10 PVDF-Doppelkone für Kapillarananschluß (AD 0,5 mm, ID 0,2 mm); 10 Filter (Edelstahl) mit PTFE-Dichtring und 10 Keramik-Vliese für HPLC-Kartuschen LiChroCART (ID 4 mm); 3 Kopplungsteile; 6 Anpreßschrauben und 6 Klemmringe für Kapillaren (AD 1/16" oder 0,5 mm); je 1 Kapillarrohr (AD 1/16", 0,25 mm) der Länge 50, 80, 120 und 200 mm; 1 totvolumenfreies Kopplungsteil für Kapillaren (AD 1/16" oder 0,5 mm); 8 Anpreßschrauben für Kapillarananschluß und 10 Klemmringe für Kapillarananschluß (AD 1/16"); 3 Edelstahikapillaren (AD 0,5 mm, ID 0,2 mm), Länge 1000 mm; 2 Langhals-rändelschrauben und 6 PVDF-Doppelkone für 6-Wege-Injektionsventile (Typ Rheodyne 7125); 10 PVDF-Doppelkone für Kapillarananschluß (AD 1/16")	696,00
1.51193.0001	Inline Filterhalterung (Satz)	103,00
1.51192.0001	Inline Filter ADS PEEK (5 Stk)	138,00
1.51194.0001	Filtereinsatz Inline 2 µm (10 Stk)	75,10

LiChroCART®

manu-fix®

Best.-Nr.	Beschreibung	€
1.16333.0001	manu-fix Halter f. LiChroCART® 4-4 Vorsäulen 1 Halterung, zweiteilig, Edelstahl	155,00

Micro Flow Splitter

Best.-Nr.	Beschreibung	€
1.51188.0001	Micro flow Splitter f. d. Mikro HPLC	3.510,00

Hibar® & LiChroCART®

Zubehör

Best.-Nr.	Beschreibung	€
1.51188.0001	Micro flow Splitter f. d. Mikro HPLC	3.510,00
1.51214.0001	Montageset für Kapillarananschluß 1/16" je 1 Kapillarrohr (AD 1/16"). ID 0,25 mm) der Längen 50, 80 120 & 200 mm 1 totvolumenfreies Kopplungsteil für Kapillaren (AD 1/16") oder 0,5 mm 8 Anpreßschrauben für Kapillarananschluß (AD 1/16") 10 Klemmringe für Kapillarananschluß (AD 1/16")	281,00
1.51213.0001	Kopplungsset (totvolumenfrei) für Kapillaren 1/16" oder 0,5 mm AD 3 Kopplungsteile, 6 Anpreßschrauben, 6 Klemmringe	335,00
1.51252.0001	Kopplungsteil (totvolumenfrei) für Kapillaren 1/16" oder 0,5 mm AD (3 Stk)	196,00
1.51216.0001	Anpreßschrauben f. Kapillarananschluß 1/16" (10 Stk)	137,00
1.15545.0001	Hibar-Rändelschrauben f. Kapillarverbindungen 0,2 mm ID/AD 0,5 mm mit PVDF-Doppelkone (4 Stk)	135,00
1.51237.0001	Hibar-Rändelschrauben m. langem Hals und PVDF-Kone f. 6-Wege-Ventile (Rheodyne) 2 Rändelschrauben (Edelstahl), 6 PVDF-Doppelkone	174,00
1.51217.0001	Schneidringe für Kapillarananschluß 1/16" 20 Klemmringe (Kegelwinkel 18°, Edelstahl)	120,00
1.51238.0001	Hibar-PVDF-Doppelkone für Kapillarananschluß 1/16" mit Rändelschraube (10 Stk)	126,00
1.15546.0001	Hibar-PVDF-Doppelkone (10 Stk)	360,00
1.51218.0001	Verschlußschrauben PVDF (20 Stk)	43,90
1.16217.0001	Vorsäulenhalterung für PVDF-Kartuschen 4-4	146,00